



Department of Chemical Engineering

FLUID MECHANICS LAB

CHE-320 Manual

Instructors:

Dr. Karim Kriaa

Eng.Najem Alarwan

STUDENT NAME:

STUDENT NUMBER:

SEMESTER / YEAR:

Table of Contents

EXPERIMENT NUMBER	Page No.
LIST OF FIGURES	3
IMPORTANT SAFETY INFORMATION	4
Experiment # 1	5
Objective: To observe laminar, transitional and turbulent pipe flow using Reynolds dye experiment ..	5
Experiment # 2	10
Objective: To investigate the operation and characteristics of three different basic types of flow meter	10
Experiment # 3	14
Objective	14
a) To determine the relationship between head loss due to friction and velocity of flow of water through smooth bore pipes	14
b) To confirm the head loss predicted by a pipe friction equation	14
Experiment # 4	18
Objective: To determine the head loss associated with flow of the water through standard fittings used in plumbing installations	18
Experiment # 5	20
Objective: To determine the relationship between fluid friction coefficient and Reynolds' number for flow of water through a roughened bore	20
Experiment # 6	23
Objective: To determine the head / flow rate characteristics of a centrifugal pump for a number of different configurations	23
Experiment # 7	29
Objectives	29
a) To demonstrate the appearance and sound of cavitation in a hydraulic system	29
b) To demonstrate the conditions for cavitation to occur (liquid at its vapor pressure).....	29
c) To observe the difference between air release from water and true cavitation	29
d) To show how cavitation can be prevented by raising the static pressure of a liquid above its vapor pressure	29

LIST OF FIGURES

Figure 1: Fully developed laminar flow	5
Figure 2: Laminar, Transitional and Turbulent flow	5
Figure 3: Reynolds' Demonstration Apparatus	6
Figure 4: Orifice Plate, Nozzle and Venturi type flow meters	10
Figure 5: Graphs of h vs. u and $ h $ vs. $ u $	14
Figure 6: Equipment diagram for pipe friction apparatus	15
Figure 7: Centrifugal Pump	23
Figure 8: Head difference	24
Figure 9: Single Pump Operation	25
Figure 10: Series Pump Operation	25
Figure 11: Parallel Pump Operation	26

IMPORTANT SAFETY INFORMATION:

The equipment in this lab involve the use of water which under certain conditions can create health hazards due to infection by harmful micro-organisms. For example the bacterium Legionella Pneumophila will feed on any scale, rust, algae or sludge in water and will breed rapidly if temperature of water is between 20 and 45 °C. Any water containing this bacterium which is sprayed or splashed creating air-borne droplets can produce a form of pneumonia known as Legionnaires disease. This one example of a possible disease, in order to avoid such diseases the following precautions must be taken:

- Water contained within the equipment must not be allowed to stagnate and should be changed regularly.
- Rust, sludge, scale or algae should be cleaned regularly.
- Where practicable the water should be maintained below 20 degrees centigrade, if not practicable, the water should be disinfected.

The hydraulics bench operates from mains voltage electric supply, so it must be connected to a supply of same frequency and voltage as marked on the equipment or the mains lead. The equipment must be connected to a mains supply with reliable earthing. It must be used only with a fused electricity supply. It must not be operated with any of the panels removed. To give increased operator protection the equipment employs Residual Current Device (RCD) also known as Earth Leakage circuit breaker. If through misuse or accident the equipment becomes electrically dangerous, the RCD will switch off the electric supply and reduce the severity of any electric shock received by an operator to a level which under normal circumstances will not cause an injury to the operator.

Once every month the RCD should be checked by pressing the TEST button. The circuit breaker must trip when the button is pressed. Failure to trip means the operator is not protected and the equipment should be checked by a competent electrician.

The blue dye powder supplied with the Osborne Reynolds demonstration equipment can be dangerous if not handled properly. Avoid contact with skin, eyes or inhalation of dust. Always pour carefully into a container to avoid creating clouds of dust. Wash hands carefully after handling. For more details, consult the health and safety information for blue dye available with the equipment manual.

For general safety, it is advised that students should exercise caution and not insert their hands into moving machinery like pumps and motors. Also, touching electric equipment with wet hands is to be avoided in order to prevent electric shock. Do not lean against equipment whether inside or outside operation. Doing so may cause damage to the equipment or may cause error in observations during experiments.

Experiment # 1: Reynolds dye experiment

Objective:

To observe laminar, transitional and turbulent pipe flow using Reynolds dye experiment.

Background:

A flow can behave in very different ways depending upon which forces predominate within it. Slow flows are dominated by *viscous forces* and they tend to be well ordered and predictable. These are described as laminar flows. In laminar pipe flow the fluid tends to behave as if concentric layers (laminas) are sliding over each other, with a maximum velocity on the axis, zero velocity on the tube wall and a parabolic velocity distribution. This is called a fully developed laminar flow.

If the flow rate is increased it will change the behavior of the flow greatly. The *inertia* of the fluid (due to its density) becomes the dominant force. This type of flow is turbulent flow. Turbulent flows are highly random and un-steady; it is usually difficult to predict the behavior of such flows.

Transitional flow is the flow occurring between laminar and turbulent regimes.

Osborne Reynolds was a British mathematician and scientist who first distinguished between these different types of flow using Reynolds dye experiment. By injecting a dye into water flowing due to gravity and then gradually changing the flow rate, Reynolds was able to observe the three types of flows.

A flow may be laminar or turbulent depending on many factors like the diameter of the pipe, the viscosity of the fluid, the velocity of the flow etc. In order to characterize the flow, it is useful to use the dimensionless Reynolds number (Re) which can be described as *“the ratio of the inertia effects to the viscous effects in a flow”*.

Mathematically

$$Re = \frac{\text{inertiae}}{\text{viscous effects}} = \frac{\rho V D}{\mu} = \frac{V D}{\nu} = \frac{Q D}{A \nu}$$

Where ρ = density.

V = average velocity of flow in the pipe, (m/s)

D = internal diameter of the pipe (hydraulic diameter) (m)

μ = dynamic viscosity (N.s/m²)

ν = kinematic viscosity (m²/s)

Q = volume flow rate (m³/s)

A = area of pipe (m²)

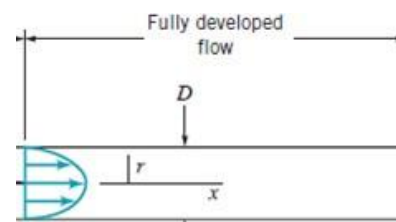

Figure 1: Fully developed laminar flow

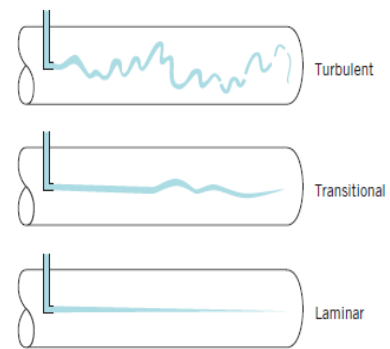

Figure 2: Laminar, Transitional and Turbulent flow

It is common practice to assume that flows with $Re < 2000$ are laminar while those with $Re > 2000$ are turbulent, but this is not an exact number and can vary depending on conditions. Generally, all pipe flows with $Re < 1800$ can be considered laminar.

Apparatus and Setup:

The following equipment is required for this experiment:

- F1-20 Reynolds' Apparatus.
- F1-10 Hydraulics Bench which will be used to measure flow by timed volume collection.
- Stopwatch and thermometer
- Dye for flow visualization

Equipment Diagram:

- 1) Dye reservoir
- 2) Dye flow control valve
- 3) Hypodermic tube
- 4) Overflow
- 5) Glass marbles
- 6) Flow control valve
- 7) Outlet pipe
- 8) Adjustable feet
- 9) **Test section (flow visualization pipe)**
- 10) Inlet pipe
- 11) Bell mouth entry
- 12) Head tank
- 13) Height adjustment screw

The inlet pipe is used to supply water to the 'constant head tank'. The purpose of the glass marbles is to eliminate any turbulence from the inlet pipe flow.

The flow visualization pipe is fitted with a bell mouth entrance to allow smooth entry into the pipe.

Water flows through the test section with the flow rate being controlled by

the 'flow control valve'. Once the desired flow has been established, dye is injected from the reservoir above in order to visualize the flow.

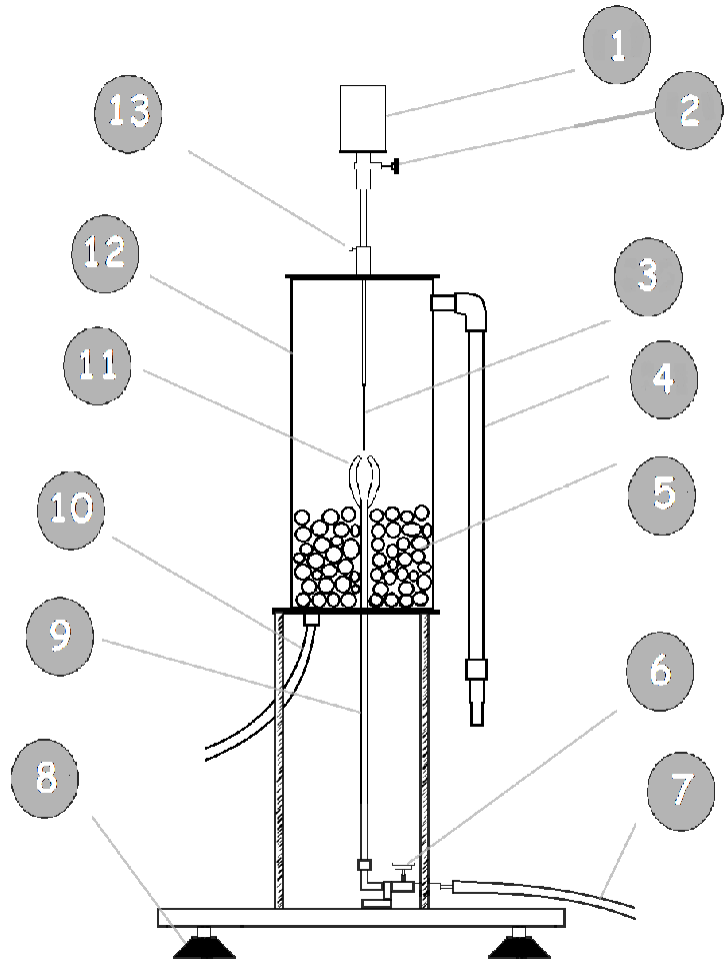

Figure 3: Reynolds' Demonstration Apparatus

Procedure:

- First, raise the water to the proper level by opening the (outlet) flow control valve slightly and adjusting the inlet valve to produce a slow trickle of water through the **overflow pipe**.
- Adjust the dye control valve until a slow flow with clear dye indication is achieved. This is to make sure that the dye is being injected properly.
- Now close the dye control valve. Wait until all the dye has exited and the test section is clear again.
- Note that the trickle of water coming from the overflow pipe should be maintained. If the outlet valve is opened more, the inlet valve should also be opened more to keep the balance.
- To observe laminar flow, open the dye control valve slightly to allow the dye to enter the bell mouth entry. Place a measuring cylinder at the end of the outlet in order to collect the water. A stop watch must be ready to time the flow as soon as the water starts collecting.
- Observe the dye flow smoothly in the test section. It will be uniform and steady.
- Measure the volume flow rate by timed collection of the water in a measuring cylinder.
- Measure the temperature of the water collected in the cylinder.
- Determine the Kinematic viscosity of the water at atmospheric pressure by checking from the given table.
- Increase the flow rate by opening the flow control valve more and repeat the dye injections.
- As the flow rate increases, transitional flow can be observed. And at high flow rates turbulent flow will be observed.
- Take at least two to three readings for each type of flow (laminar, transitional and turbulent)

Observations, Calculations and Results:

S.No	Type of flow	Volume collected (m ³)	Time to collect (s)	Pipe Area (m ²)	Volume flow rate (m ³ /s)	Kinematic Viscosity (10 ⁶ x m ² /s)	Reynolds Number
	Laminar			7.854 x 10 ⁻⁵			
	Transitional						
	Turbulent						

Discussion of Results & Conclusion:

Experiment # 2: Types of Flow meter.

Objective:

To investigate the operation and characteristics of three different basic types of flow meter.

Background:

An effective way to measure the flow rate through a pipe is to place some type of restriction within the pipe as shown in the figure, and to measure the pressure difference between the low-velocity, high-pressure upstream section, and the high-velocity, low-pressure downstream section. Three commonly used types of flow meters are shown in the figure: the *orifice meter*, the *nozzle meter*, and the *Venturi meter*. The operation of each is based on the same physical principles — an increase in velocity causes a decrease in pressure. The difference between them is a matter of cost, accuracy, and how closely their actual operation obeys the

idealized flow assumptions.

Another common type of flow meter is the

‘variable area flow meter’ (also known as *rotameter*). In this device a float is contained within a tapered and transparent metering tube that is attached vertically to the pipeline. As fluid flows through the meter entering at the bottom, the float will rise within the tapered tube and reach an equilibrium height that is a function of the flow rate. This height corresponds to an equilibrium condition for which the net force on the float (buoyancy, float weight, fluid drag) is zero. A calibration scale in the tube provides the relationship between the float position and the flow rate.

Application of the Bernoulli’s equation yields the following results for both venturi-meter and orifice plate

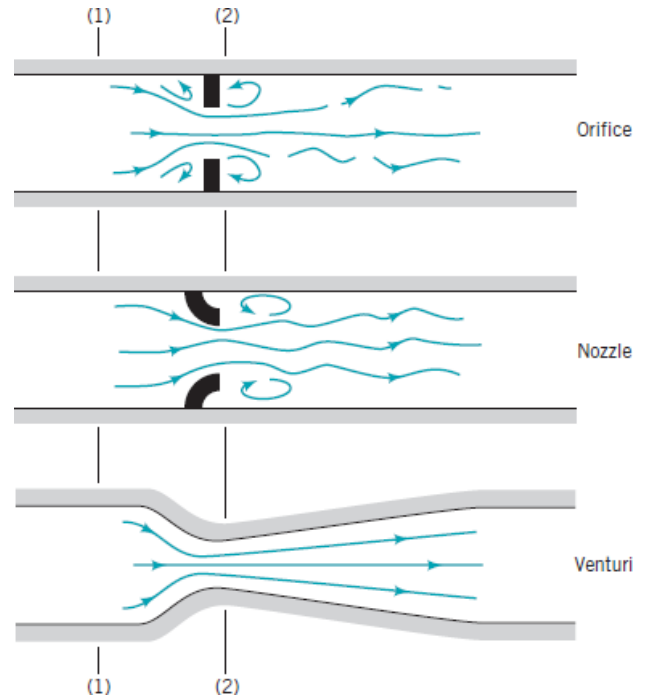

Figure 4: Orifice Plate, Nozzle and Venturi type flow meters

$$\text{Volume flow rate} = Qv = \frac{C_d A_2}{\sqrt{1 - \left(\frac{A_2}{A_1}\right)^2}} \times \sqrt{\frac{2\Delta p}{\rho}}$$

Where: $\sqrt{\frac{2\Delta p}{\rho}} = \sqrt{2g\Delta h}$

- Δh is the head difference in meters determined from the manometer readings for the appropriate meter.
- g is acceleration due to gravity in m/s^2
- C_d is the discharge coefficient for the meter as given below:
 - For venturi-meter $C_d = 0.98$
 - For orifice plate $C_d = 0.63$
- A_1 is the area of the test pipe upstream of the meter (in m^2)
- A_2 is the throat area of the meter (in m^2)

The energy loss that occurs in a pipe fitting is commonly expressed in terms of head loss (h , meters) and can be determined from the manometer readings. For this experiment, head losses will be compared against the square of the flow rate used.

Apparatus and Setup:

- The flow meter apparatus is designed to be used with the hydraulics bench for water supply so it should be placed on the bench.
- Connect the inlet pipe to the bench supply and the outlet pipe into the volumetric tank.
- Start the pump and open the bench valve and the test rig flow control valve to flush the system.
- The tubes should be free of air bubbles. In order to bleed air from the equipment, close both the bench and test rig valves, open the air bleed screw and remove the cap from the adjacent air valve.
- Connect a length of small bore tubing from the air valve to the volumetric tank.
- Next open the bench valve and allow the flow of through the manometer tubes to remove all the air.
- After this, tighten the air bleed screw and partly open the test rig flow control valve. Also partly close the bench valve.
- Now open the air bleed screw slightly to allow air to be drawn into the top of the manometer tubes. Re-tighten the screw when the manometer levels are at a convenient height.

- Check that the manometer levels are all on scale at the maximum flow rate.

Procedure:

- The procedure for this experiment is very simple. At a fixed flow rate, record all manometer heights and also record the reading on the variable area meter.
- Close the ball valve and measure the time taken to collect a certain volume of water in the tank (use a stop watch). The reading should be taken for at least one minute to minimize timing errors.

Observations, Calculations and Results:

<i>Test Pipe Area A_1 (m^2)</i>	<i>Orifice Area A_2 (m^2)</i>	<i>Venturi Area A_2 (m^2)</i>	<i>Volume Collected V (m^3)</i>	<i>Time to collect T (sec)</i>	<i>Variable Area Meter Reading (1/min)</i>	h_1 (nm)	h_2 (nm)	h_3 (nm)	h_4 (nm)	h_5 (nm)	h_6 (nm)	h_7 (nm)

h_1 (nm)	<i>Timed Flow Rate Q_t (m^3/sec)</i>	<i>Variable Flow Rate Q_a (m^3/sec)</i>	<i>Orifice Plate Flow Rate Q_o (m^3/sec)</i>	<i>Venturi Meter Flow Rate Q_v (m^3/sec)</i>	<i>Variable Area % Flow Rate Error (%)</i>	<i>Orifice Plate % Flow Rate Error (%)</i>	<i>Venturi Meter % Flow Rate Error (%)</i>	<i>Variable Area Head Loss (H_a)</i>	<i>Orifice Plate Head Loss (H_o)</i>	<i>Venturi Meter Head Loss (H_v)</i>	<i>Time d Flow Rate Squared (Q_t^2)</i>

Name	Unit	Symbol	Type	Definition
Test pipe area	m ²	A ₁	Given	Cross-sectional area of the test section.
Orifice area	m ²	A ₂	Given	Cross-sectional area of the orifice in the orifice plate meter.
Venturi area	m ²	A ₂	Given	Cross-sectional area of the narrowest section of the Venturi meter.
Volume collected	m ³	V	Measured	Taken from scale on hydraulics bench. The volume is measured in liters. Convert to cubic meters for the calculation (divide reading by 1000)
Time to collected	s	t	Measured	Time taken to collect the known volume of water in the hydraulics bench.
Variable area meter reading	L/min		Measured	Reading from variable area meter scale.
h _x	m		Measured	Measured value from the appropriate manometer. The value is measured in mm.
Timed flow rate	m ³ /s	Q _t	Calculated	$Q_t = \frac{V}{t} = \frac{\text{Volume collected}}{\text{Time to collect}}$
Variable area flow rate	m ³ /s	Q _a	Calculated	Convert from instrument reading (divide by 60,000)
Orifice plate flow area	m ³ /s	Q _o	Calculated	$Q_o = \frac{C_d A_2}{\sqrt{1 - \left(\frac{A_2}{A_1}\right)^2}} \times \sqrt{\frac{2\Delta p}{\rho}}$
Venturi meter flow rate	m ³ /s	Q _v	Calculated	$Q_v = \frac{C_d A_2}{\sqrt{1 - \left(\frac{A_2}{A_1}\right)^2}} \times \sqrt{\frac{2\Delta p}{\rho}}$
Variable area% flow rate error		%	Calculated	$((Q_a - Q_t)/Q_t) * 100$

Orifice plate % flow rate error		%	Calculated	$((Q_o - Q_t)/Q_t) * 100$
Venturi meter % flow rate error		%	Calculated	$((Q_v - Q_t)/Q_t) * 100$
Variable area head loss	mm	H_a	Calculated	$H_a = h_4 - h_5$
Orifice plate head loss	mm	H_o	Calculated	$H_o = h_6 - h_8$
Venturi plate head loss	mm	H_v	Calculated	$H_v = h_1 - h_3$
Timed flow rate squared		Q_c^2	Calculated	Used to demonstrate the relationship between flow rate and losses.

Type of flow meter	Technical data
Venturi meter	Upstream pipe diameter = 0.03175 m
	Cross sectional area of upstream pipe $A_1 = 7.92 \times 10^{-4} \text{ m}^2$
	Throat diameter = 0.015 m
	Cross sectional area of throat $A_2 = 1.77 \times 10^{-4} \text{ m}^2$
	Upstream taper = 21 degrees
	Downstream taper = 14 degrees
Orifice meter	Upstream pipe diameter = 0.03175 m
	Cross sectional area of upstream pipe $A_1 = 7.92 \times 10^{-4} \text{ m}^2$
	Throat diameter = 0.020 m
	Cross sectional area of throat $A_2 = 3.14 \times 10^{-4} \text{ m}^2$

The manometers are connected so that the following pressure differences can be obtained:

- $h_1 - h_2$ Venturi meter reading
- $h_1 - h_3$ Venturi loss
- $h_4 - h_5$ Variable area meter loss
- $h_6 - h_7$ Orifice plate reading
- $h_6 - h_8$ Orifice plate loss

Discussion of Results & Conclusions:

Experiment # 3 Head loss due to friction and velocity of flow

Objective:

- a) To determine the relationship between head loss due to friction and velocity of flow of water through smooth bore pipes
- b) To confirm the head loss predicted by a pipe friction equation

Background:

It was first demonstrated by Professor Osborne Reynolds that two types of flows may exist in a pipe:

1. Laminar flow at low velocities (where head loss h is directly proportional to fluid velocity u) i.e. $h \propto u$
2. Turbulent flow at higher velocities where $h \propto u^n$

These two types of flows are separated by a transition phase where no definite relationship between h and u exists. A graph of h vs. u and $|h|$ vs. $|u|$ can be drawn to show these zones.

For a circular pipe with fully developed flow, the head loss due to friction may be calculated from the formula:

$$h = \frac{\lambda L u^2}{2 g d}$$

Where:

- L is the length of pipe between the tapping.
- d is the internal diameter of the pipe
- u is the mean velocity of water through the pipe (in m/s)
- g is acceleration due to gravity (m/s^2)
- λ is the pipe friction coefficient

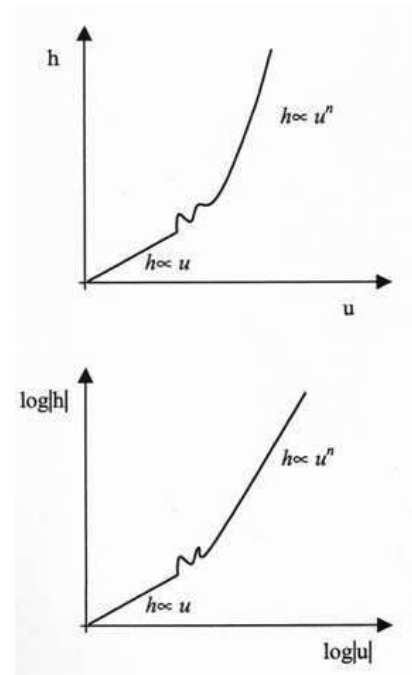
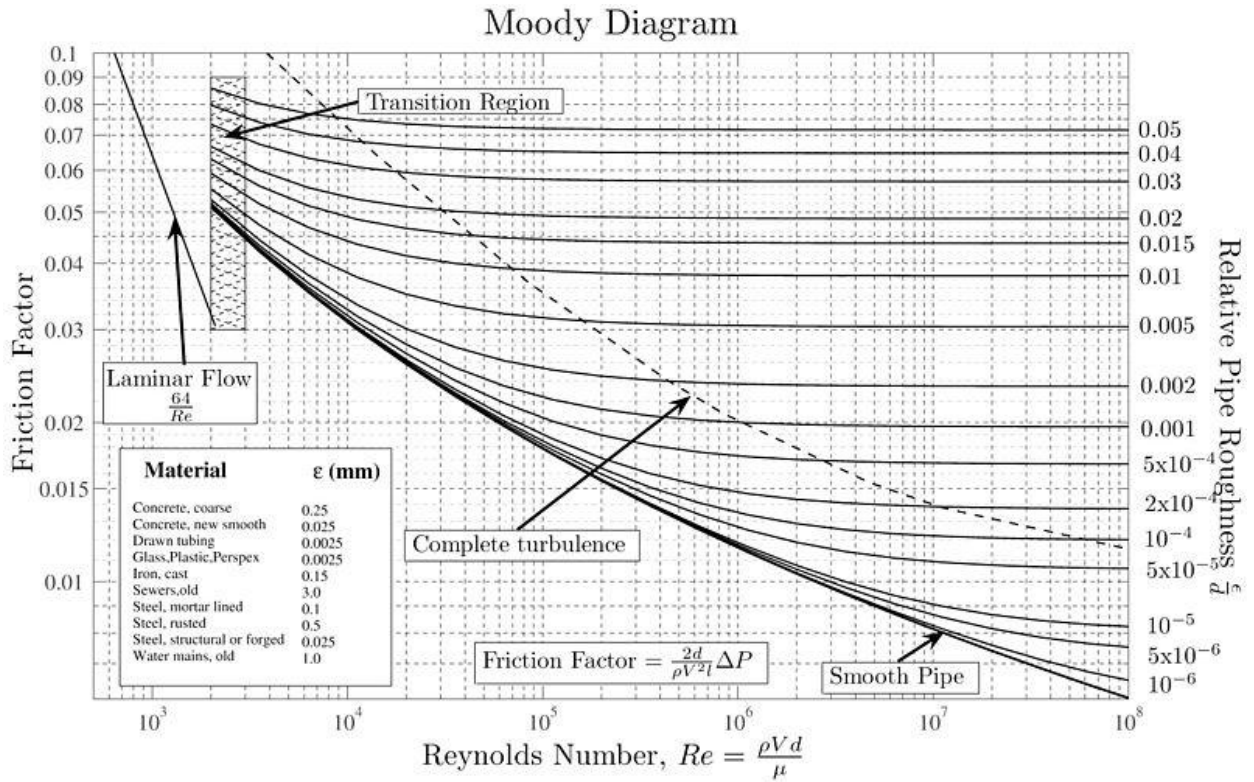

Figure 5: Graphs of h vs. u and $|h|$ vs. $|u|$

Reynolds number can be found using:

$$\text{Re} = \frac{\rho V D}{\mu}$$

After determining the Reynolds number for the flow in the pipe, the value of λ may be determined using Moody diagram.



Apparatus and Setup:

This equipment does not require any special setup before the experiment. However it should be ensured that the flow occurs only through the test pipe under observation. In this case there are different pipe sizes for each of which the data must be recorded. Before starting the experiment the pipe network should be primed with water.

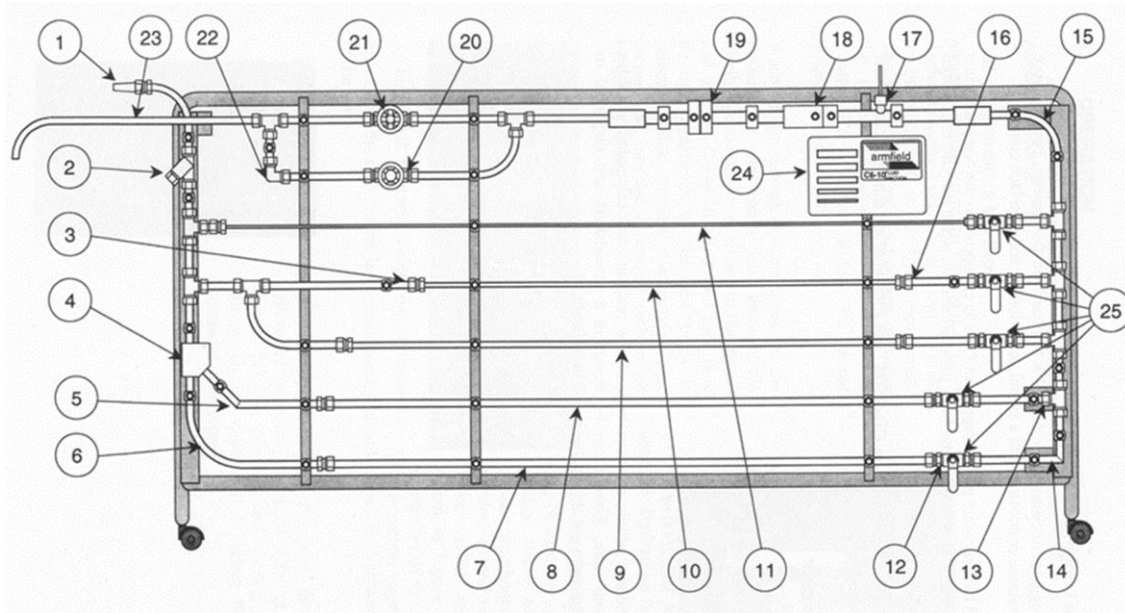

Figure 6: Equipment diagram for pipe friction apparatus

The test pipes and fittings are mounted on a tubular frame carried on castors. Water is fed in from the hydraulics bench via the barbed connector (1), flows through the network of pipes and fittings, and is fed back into the volumetric tank via the exit tube (23). The pipes are arranged to provide facilities for testing the following:

- An in-line strainer (2)
- An artificially roughened pipe (7)
- Smooth bore pipes of 4 different diameters (8), (9), (10) and (11)
- A long radius 90° bend (6)
- A short radius 90° bend (15)
- A 45° "Y" (4)
- A 45° elbow (5)
- A 90° "T" (13)
- A 90° mitre (14)
- A 90° elbow (22)
- A sudden contraction (3)
- A sudden enlargement (16)
- A pipe section made of clear acrylic with a Pitot static tube (17)
- A Venturi meter made of clear acrylic (18)
- An orifice meter made of clear acrylic (19)
- A ball valve (12)
- A globe valve (20)
- A gate valve (21)

Short samples of each size test pipe (24) are provided loose so that you can measure the exact diameter and determine the nature of the internal finish. The ratio of the diameter of the pipe to the distance of the pressure tappings from the ends of each pipe has been selected to minimize end and entry effects.

A system of isolating valves (25) is provided whereby the pipe to be tested can be selected without disconnecting or draining the system. The arrangement also allows tests to be conducted on parallel pipe configurations.

Each pressure tapping is fitted with a quick connection facility. Probe attachments with an adequate quantity of translucent polythene tubing are provided, so that any pair of pressure tappings can be rapidly connected to the pressure measurement system.

Procedure:

- After priming, take readings at ten different flow rates in order to draw an accurate graph. The flow rates can be changed by using the control valve on the hydraulics bench.
- The flow rates can be measured using volumetric tank. For small flow rates a measuring cylinder may be used. Measure the head loss between the tappings using the portable pressure meter or manometer.
- Obtain readings on all four smooth test pipe

Observations, Calculations and Results:

Complete the table below and then plot a graph of h vs. u for each size of pipe. Identify the laminar, transition and turbulent zones on the graphs.

Volume V (liters)	Time t (Secs)	Flow rate Q (m ³ /s)	Pipe dia. d (m)	Velocity u (m/s)	λ	Head loss Calculated h _c (meters of water)	Head loss Measured h (meters of water)		
							h ₁	h ₂	h = Δh
		$\frac{V \times 10^{-3}}{t}$		$\frac{4Q}{\pi d^2}$	From Moody diagram	$\frac{\lambda L u^2}{2 g d}$			

Discussion of Results & Conclusions:

Experiment # 4: Fluid Friction Coefficient

Objective:

To determine the relationship between fluid friction coefficient and Reynolds' number for flow of water through a roughened bore.

Background:

The head loss due to friction in a pipe is giving by:

$$h = \frac{\lambda L u^2}{2 g d} = \frac{4 f u^2}{2 g d}$$

Where:

- L is the length of pipe between the tapping.
- d is the internal diameter of the pipe
- u is the mean velocity of water through the pipe (in m/s)
- g is acceleration due to gravity (m/s²)
- f is the pipe friction coefficient (The US equivalent of the British term 'f' is λ ,
Where: $\lambda = 4f$)

$$Re = \frac{\rho V D}{\mu}$$

After determining the Reynolds number for the flow in the pipe, the value of λ may be determined using Moody diagram.

Apparatus and Setup:

This equipment does not require any special setup before the experiment. However it should be ensured that the flow occurs only through the test pipe under observation. Before starting the experiment the pipe network should be primed with water.

Procedure:

- After priming, take readings at several different flow rates in order to draw an accurate graph. The flow rates can be changed by using the control valve on the hydraulics bench.
- The flow rates can be measured using volumetric tank. For small flow rates a measuring cylinder may be used. Measure the head loss between the tappings using the portable pressure meter or manometer.

- Estimate the nominal internal diameter of the test pipe sample using a Vernier caliper and estimate the roughness factor k/d

Observations, Calculations and Results:

Complete the table below and then plot a graph of h vs. u for each size of pipe. Identify the laminar, transition and turbulent zones on the graphs.

Volume V (litres)	Time t (Secs)	Flow rate Q (m ³ /s)	Pipe dia. d (m)	Velocity u (m/s)	Reynolds Number Re	Head loss Measured h (meters of water)			Friction coefficient F
						$h = \Delta h$	h_1	h_2	
		$\frac{V \times 10^{-3}}{t}$		$\frac{4 Q}{\pi d^2}$	$\frac{\rho u D}{\mu}$				$\frac{g d h}{2 L u^2}$

Pipe length = $l =$ _____ m

Roughness height = $k =$ _____ m

Plot a graph of pipe friction coefficient vs. Reynolds number (use log scale). Note the difference from the smooth pipe curve on the Moody diagram when the flow is turbulent.

Discussion of Results & Conclusions:

Experiment # 5: Head Loss Associated with Standard Fittings

Objective:

To determine the head loss associated with flow of the water through standard fittings used in plumbing installations.

Background:

The head loss in a pipe fitting is proportional to the velocity head of the fluid flowing through the fitting

$$h = \frac{Ku^2}{2g}$$

Where K = fitting loss factor, u = mean velocity of water through the pipe (m/s) and g = acceleration due to gravity (m/s²)

Note that a flow control valve is a pipe fitting which has an adjustable K factor. The minimum value of K and the relationship between stem movement and K factor are important for selecting a value for an application.

Apparatus and Setup:

The following fittings and valves are available for test

- Sudden contraction
- Sudden enlargement
- Ball valve
- 45° elbow
- 45° mitre
- 45° Y-junction
- Gate valve
- Globe valve
- Inline strainer
- 90° elbow
- 90° short radius bend
- 90° long radius bend
- 90° T-junction

This equipment does not require any special setup before the experiment. However it should be ensured that the flow occurs only through the test pipe under observation. In this case there are different pipe sizes for each of which the data must be recorded. Before starting the experiment the pipe network should be primed with water.

Procedure:

- After priming, take readings at several different flow rates. The flow rates can be changed by using the control valve on the hydraulics bench.
- The flow rates can be measured using volumetric tank. For small flow rates a measuring cylinder may be used.
- Measure the differential head between theappings on each fitting using the portable pressure meter or manometer.

Observations, Calculations and Results:

All readings should be tabulated as follows. Confirm that K is constant for each fitting over the range of test flow rates. Plot a graph of K factor vs. valve opening for each test valve and note differences in test characteristics.

Volume V (litres)	Time t (Secs)	Flow rate Q (m ³ /s)	Pipe dia. d (m)	Velocity u (m/s)	Velocity head loss h _v (meters of water)	Measured Head loss h (meters of water)			Pipe fitting factor K	Valve position
						h = Δh	h ₁	h ₂		
		$\frac{V \times 10^{-3}}{t}$		$\frac{4 Q}{\pi d^2}$	$\frac{u^2}{2 g}$				$\frac{h}{h_v}$	

Discussion of Results & Conclusions:

Experiment # 6: Centrifugal Pump

Objective:

To determine flow rate of a centrifugal pump for a number of different configurations and determine power pump output.

Background:

Centrifugal pumps are commonly used in homes and industries and it is important for an engineer to know about the performance and selection of such pumps. In this type of pump the fluid is drawn into the center of a rotating impeller and is thrown outwards by centrifugal action. As a result of the high speed of rotation the liquid acquires high kinetic energy. The pressure difference between the suction side and the discharge side arises from the conversion of this kinetic energy into pressure. The

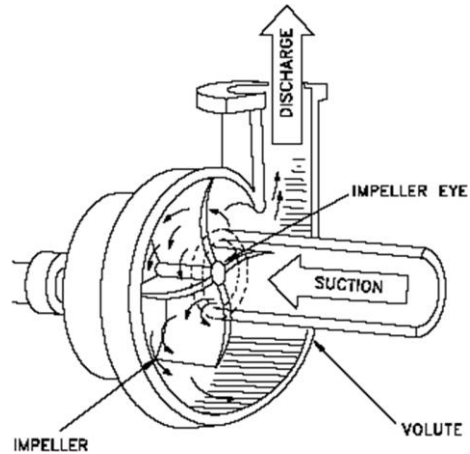

Figure 7: Centrifugal Pump

centrifugal pump is a radial flow device.

Starting from the general form of the energy equation:

$$-W = d\left(\frac{v^2}{2}\right) + g \cdot dz + \int vol \cdot dp + F$$

For the case of water (incompressible fluid), this equation simplifies to the Bernoulli equation which can be applied between the inlet and outlet of the pump (neglecting friction).

$$W = \left(\frac{v_2^2 - v_1^2}{2}\right) + g \cdot (z_2 - z_1) + \left(\frac{P_2 - P_1}{\rho}\right)$$

Negligible since $v_1 \approx v_2$

Where:

-W = the work done by the pump shaft

F = the frictional energy loss to the surroundings (which may cause heating up of the water)

Vol. = the specific volume of the flu

Apparatus and Setup:

This experiment will investigate the performance of pumps in three different configurations:

- Single pump operation.
- Two pumps combined in series.
- Two pumps combined in parallel.

The different configurations are shown in the respective figures.

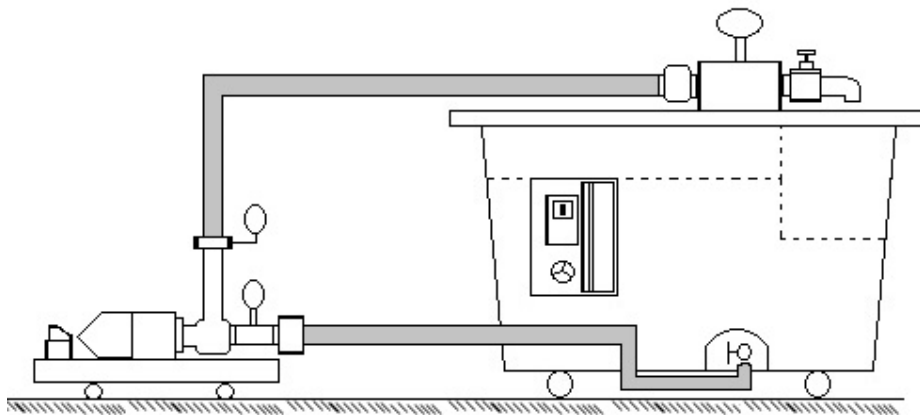

Figure 9: Single Pump Operation

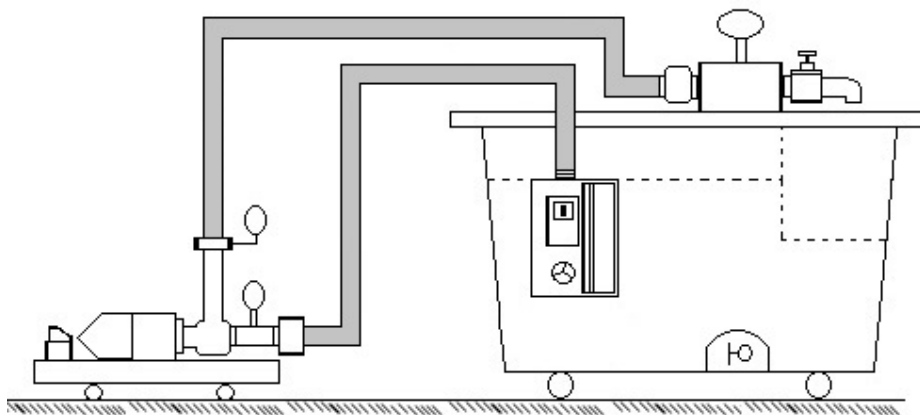

Figure 10: Series Pump Operation

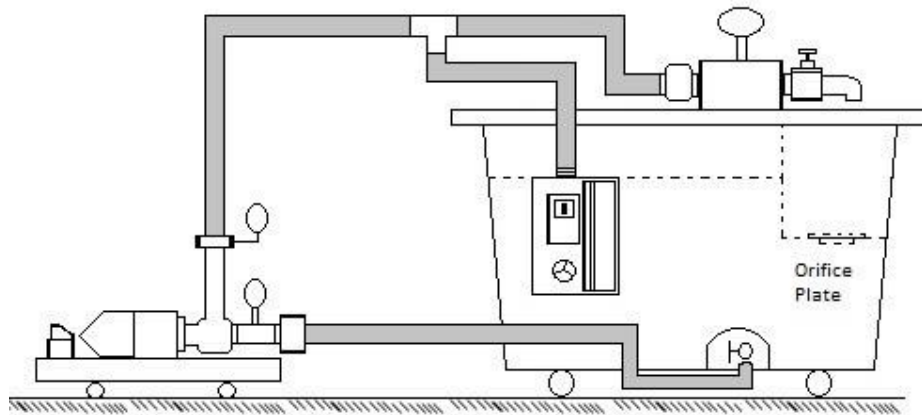

Figure 11: Parallel Pump Operation

Procedue:

- All pipe connections for the different configurations are already fitted. The only thing that is required is to open and close the appropriate valves and pumps in order to enable the required configuration.
- The objective is to measure head vs. flow rate. First, enable the single pump configuration by FULLY opening the sump drain valve (at the bottom of the hydraulics bench) to the external pump. Close the valve connecting the internal pump of the bench with the external pump.
- Make sure the internal pump of the bench is switched off and the bench flow control valve is closed.
- Switch on the external pump and completely open the discharge valve.
- It will be observed from the discharge pressure gage that the discharge pressure is low when the flow rate is high.
- Take a set of readings at a range of head values. Vary the head using the discharge control valve and include data for zero flow-rate with the valve fully closed.
- For each head value, perform timed volume collection to find the flow rate.
- Repeat the above steps for series configuration and then for parallel configuration.
- Finally switch of all the pumps and end the experiment.

Observations, Calculations and Results:

Observations table and space left blank for calculations and results

Type of configuration	Volume of Water V (m ³)	Time to collect t (sec)	Flow Rate Q _v (m ³ /s)	Pump Power Output W _o (Watts)	Efficiency η %
Single Pump Operation					
Series Pump Operation					
Parallel Pump Operation					

$$\text{Flow rate } (Q_v) = \frac{V}{t} \text{ (m}^3\text{/s)}$$

$$W_o = H * Q_v * \rho * g$$

$$\eta = W_o / W_i$$

W_i: pump power input.

H: vertical distance = 0.90 m.

ρ: density of water.

g= acceleration gravity.

Discussion of Results & Conclusions:

Experiment # 7: Cavitation

Objectives:

- a) To demonstrate the appearance and sound of cavitation in a hydraulic system
- b) To demonstrate the conditions for cavitation to occur (liquid at its vapor pressure)
- c) To observe the difference between air release from water and true cavitation
- d) To show how cavitation can be prevented by raising the static pressure of a liquid above its vapor pressure

Background:

Cavitation is the name given to the phenomena that occurs at the solid boundaries of liquid streams when the pressure of the liquid is reduced to an absolute pressure that equals the vapor pressure of the liquid at the prevailing temperature. The static pressure in the liquid cannot fall below the vapor pressure and any attempt to reduce the static pressure below the vapor pressure merely causes the liquid to cavitate (vaporize) more vigorously.

Once the static pressure is reduced to the vapor pressure an audible crackling noise will be noticed that is created by the generation of vapor bubbles. If the sides of the pipe or the container are transparent then the milky appearance of the liquid, caused by the generation of vapor bubbles can be viewed as is the case in the venturi shaped test section of the cavitation demonstration apparatus.

Dissolved air in the water will also create air bubbles that look similar to cavitation but the air bubbles will be released at a higher static pressure (above the vapor pressure of the liquid). The release of the air bubbles is by no means as violent as cavitation and a softer noise is produced. As the static pressure of the liquid is gradually reduced below atmospheric pressure, air bubbles will be visible followed by true cavitation as the vapor pressure of the liquid is reached.

The bubbles of vapor formed in the region of low static pressure move downstream to a region of higher static pressure, where they collapse. This repeated formation and collapse of vapor bubbles can have such a devastating effect upon pipe walls, turbine blades, pump impellers etc. by causing pitting of the surface. The actual time between formation and collapse may be no more than $1/100^{\text{th}}$ of a second, but the dynamic pressure caused by this phenomenon may be very severe. It is only a matter of having enough bubbles formed over a sufficient period of time for the destruction of the surface to begin.

Bernoulli's equation:

$$P_1 + \frac{1}{2} \rho v_1^2 + \rho g h_1 = P_2 + \frac{1}{2} \rho v_2^2 + \rho g h_2$$

Apparatus and Setup:

Cavitation is demonstrated by forcing water through a contraction so that the static pressure of the water reduces. When the static pressure is reduced any air dissolved in the water is released as bubbles. When the static pressure is reduced to the vapor pressure of the water, violent cavitation (vaporization) of the water occurs. By restricting the flow downstream of the test section the static pressure in the test section is increased. When the static pressure is maintained above the vapor pressure increased flow rate is possible through the test section without cavitation occurring.

In accordance with the Bernoulli's equation the pressure at the throat of the Venturi shaped test section falls as the velocity of the water increases. However, the pressure can only fall as far as the vapor pressure of the water at which point the water starts to vaporize and cavitation occurs. Any further increase in velocity cannot reduce the pressure below the vapor pressure so the water vaporizes faster - hence stronger cavitation occurs and Bernoulli's equation is not observed.

The following dimensions from the equipment are applicable:

- Test Section upstream diameter d1 16.0 mm
- Test Section throat diameter d2 4.5 mm
- Test section downstream diameter d3 16.0 mm
- Following are the steps for setting up the cavitation demonstration apparatus
- Locate the Cavitation Demonstration Apparatus on the top of the Hydraulics Bench.
- Connect the flexible tube at the left hand end of the apparatus to the water outlet on the bench (it will be necessary to remove the yellow quick release connector before screwing the fitting onto the outlet. To aid assembly the flexible tube can be disconnected from the cavitation demonstration apparatus by unscrewing the union on the valve. Ensure that the union is tightened (hand tight only) following reassembly.
- Locate the flexible tube at the right hand end of the apparatus inside the volumetric tank of the bench with the end inside the stilling baffle to minimize disturbances in the volumetric tank.
- Note that when operating the apparatus near or at the vapor pressure of the liquid the vacuum gage will be slow to respond. This is because the liquid inside the gage turns to water vapor when operating at vapor pressure and this process will not be instantaneous. The effect is more noticeable when the pressure is raised and cavitation stops visibly and audibly in the test section.

Procedure:

1. Open the ball valve (right hand end) fully then close the inlet diaphragm valve (left hand only) fully.
2. Close the flow control valve on the bench. Switch on the bench then slowly open the flow control valve on the bench until it is fully open.
3. Slowly open the inlet diaphragm valve at the left hand end of the apparatus and allow water to flow through the apparatus until the clear acrylic test section and flexible connecting tubes are full of water and no air remains entrained.
4. Continue to open the inlet diaphragm valve slowly until fully open to obtain maximum flow through the system.
5. Note the milky formation at the throat indicating the presence of cavitation. Also note the loud audible cracking sound accompanying the cavitation. Note that the sound can be amplified by placing the blade of a large screwdriver or similar tool against the body of the venturi shaped test section then placing your ear against the handle of the screwdriver.
6. Observe that the visible cavitation occurs in the expansion of the test section and not in the throat where the pressure is at the lowest (with the exception of the pressure tapping hole in the throat that causes a local disturbance to the flow).
7. If a thermometer is available measure and record the temperature of the water.

This completes the demonstration of the appearance and sound of cavitation in a hydraulic system. The following will demonstrate the conditions for cavitation to occur (i.e. liquid at its vapor pressure) and the difference between air bubble release and true cavitation.

1. Close the inlet diaphragm valve until water flows slowly through the equipment with no cavitation in the test section (typically 0.1 bar on the upstream gage P_1). Make sure that the test section remains full of water.
2. Record P_1 , P_2 and P_3 (upstream, at the throat and downstream)
3. Determine the flow rate by timing the collection of a known volume of water.
4. Gradually open the inlet diaphragm valve to increase the upstream pressure in small steps (use 0.1 bar increments for P_1)
5. At each setting repeat steps 2 and 3 and note the presence of any tiny bubbles in the water. Wait for the vacuum gage needle to settle before recording the pressure at the throat. (This will take some time when you get close to cavitation conditions, because water inside the gage is converting from liquid to vapor).
6. Observe the change in appearance and the change in sound when the pressure at the throat reaches the vapor pressure. (Air bubbles are released from the water at high static pressure make a softer noise which is not true cavitation). Also observe that the pressure at the throat does not continue to fall below the vapor pressure of the water as the flow of the water is increased.

7. Continue opening the inlet diaphragm valves in steps and record the changes until the maximum flow rate of water is achieved with the valve fully opened.

Discussion of Results & Conclusion:

